

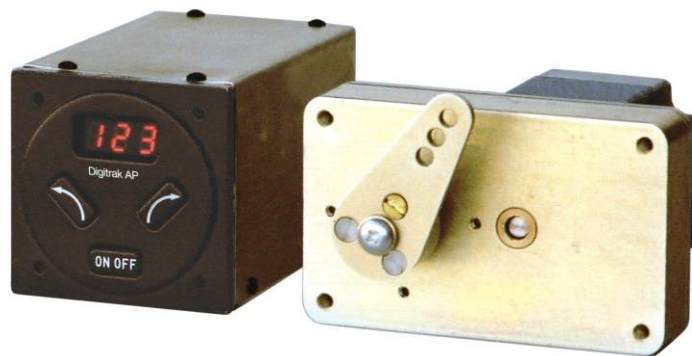

## **Installation & User Guide**

**For**



## **DigiTrak Autopilots**

**TRUTRAK FLIGHT SYSTEMS**

**1500 S. Old Missouri Road**

**Springdale, AR 72764**

**Ph. 479-751-0250 Fax 479-751-3397**

[www.trutrakflightsystems.com](http://www.trutrakflightsystems.com)

# INSTALLATION MANUAL

for

DigiTrak Autopilots

## TABLE OF CONTENTS

Power Up .....	1
Basic Operation .....	1
Nav Mode Operation .....	1
Mechanical Considerations.....	2
Magnetic Considerations .....	3
RFI / EMI Considerations.....	3
Connecting GPS Units	
GPS Setup Guide .....	3
Portable GPS's .....	3
Panel mount GPS's .....	6
Ground Checkout.....	8
First Flight .....	10
Magnetic Calibration .....	11
Definitions .....	12
DigiTrak Settings.....	12
Electrical Pin-out .....	13
DigiTrak Wiring Diagram .....	14
DigiTrak Block Diagram .....	15

## Power Up











**NOTE: When powering up the autopilot ensure that the aircraft is as still as possible for 10 seconds.**

The power up of the autopilot takes approximately ten seconds. During the power cycle it is very important that the aircraft be as still as possible for the initialization of the internal gyro. While the autopilot is in the power up the display will show three flashing (“-”) characters. If there is a GPS signal present the display will now change to read (“OFF”). If there is not a valid GPS signal present the display will show three non-flashing (“-”) characters.



## Basic Operation

Once the aircraft is off the ground and at a safe altitude, the autopilot can be engaged. There are two ways to engage the autopilot. Pressing the **ON/OFF** button will engage the autopilot. If a GPS signal is present, the autopilot will display the current track and will now hold the track. If there is no GPS signal the display will show “-|-” and will be in “heading hold” mode instead of track hold mode. The second way to engage the autopilot is with the Control-Wheel Switch, pushing and holding the control wheel switch for approximately 1-1/2 seconds and releasing will engage the autopilot.

Changing the selected track can be done several different ways. One way in which the track can be changed is to momentarily push and release the  or  button. This will result in a one-degree change in selected track. If there is no GPS signal present momentary push and release the  or  button will result in approximately a one degree change in heading. The second way to change the selected track is to push and hold the  or  button. After approximately 1-1/2 seconds the autopilot will enter a constant-rate turn. While turning, if a GPS signal is present, the display of the autopilot will be a digital DG displaying a gyroscopically smoothed GPS track throughout the turn. When the desired track is displayed on the autopilot, push and release the opposite  or  button. The autopilot will now stop the turn and fly the new selected track. Note that when the button is pushed to stop the turn, the aircraft is still in a bank; therefore the autopilot will have to stop the turn and fly back to the selected track. If there is no GPS signal present, and the autopilot is put into the constant rate turn mode, the display will show a stroboscopically-moving symbol in the direction of the selected turn. The final way to change the selected track is with the Control-Wheel Switch. Pushing and holding the Control-Wheel Switch will disengage the servo and the display on the autopilot will be a Digital DG. While holding the Control-Wheel Switch, fly the aircraft manually to the desired track using the Digital DG display as a reference. Upon release of the Control-Wheel Switch, the servo will re-engage and the autopilot will now fly the new selected track. If there is no GPS signal present the Digital DG will not be displayed.

Disengaging the autopilot can be done in two different ways. Pressing the **ON/OFF** button will disengage the autopilot. The second way to disengage the autopilot is with the Control-Wheel Switch. Momentarily pushing and releasing the Control-Wheel Switch will disengage the autopilot.

## Nav Mode Operation

When the autopilot is engaged and there is a flight plan present in the GPS, every 3-4 seconds the display will flash (“- F -”). This is to alert the pilot that the autopilot is receiving a valid GPS flight plan. To enter the Nav Mode, momentarily push the  and  buttons at the same time. (Take care not to hold both buttons in for too long a time, or the autopilot will enter the setup mode instead.) The autopilot display will now begin flashing the Digital DG reading as it maneuvers to intercept the course line. Once the course-line is intercepted and the autopilot has turned within a few degrees of the desired track, the display will change from the flashing DG to (“- 0 -”) indicating that the autopilot is now tracking the course line. Pushing any button on the autopilot will exit the Nav Mode. When on course, 1 or 2-degree excursions are normal. When the end of the flight plan is reached or the flight plan is cancelled on the GPS unit, the autopilot will continue flying the track it was flying when the flight plan ended. If the flight plan has multiple waypoints, the autopilot will make the necessary turn at each waypoint. Because, typically, the information from the GPS to the autopilot does not change until the waypoint is crossed, the autopilot will over-fly the waypoint, and then will fly back to intercept the new course line. Some GPS units have a “turn anticipation” feature, and if this feature is enabled on the GPS the autopilot may turn prior to reaching a given waypoint.

## Mechanical Considerations



The installation information in this section is extremely important and must be clearly understood by the installer. Improper servo installation or failure to observe and diagnose installation problems prior to flight can result in extremely serious consequences, **including loss of ability to control the aircraft**. If there are any questions on the part of the installer it is mandatory to resolve these questions prior to flight of the aircraft.

Most modern experimental aircraft use push-pull tubes to drive the primary controls. These tubes generally have a total travel of 3" or less; therefore, it is best to connect the autopilot servo to the primary control by the same method. This connection consists of an arm on the servo connected by a push-pull rod to the primary control. Rod-end bearings are required on each end of the push-pull rod.



The servo arm **must not** rotate even **near** to the point called OVER CENTER, the point at which the primary aircraft control would **lock up**. Some aircrafts mechanical primary control installations will not allow this to occur and do not need the servo stops.

This is a condition that would result from the servo being back driven when the pilot operates the controls, or from the servo itself driving the controls to a stop. To protect against this mechanical stops are supplied with the servos. These stops are drilled so that they can be mounted at different angles as required (18° intervals).



In addition to the proper use of the stop it is important to know the amount of travel on the primary control that the servo can handle. With the push rod connected to the outermost hole (1 1/2") the travel on the primary cannot exceed 2 1/2", the intermediate hole 2 1/16", and the inner hole 1 5/8".



It is important to note that the servo travel should be very nearly the same in both directions. In most cases this means that the servo arm needs to be perpendicular to the push rod but there are exceptions such as the RV-4 and RV-8 installations.

There will be installations in which space does not permit the use of the stop. When this is done the aircraft's primary control stops must be positive and care must be taken to be sure that the servo drives the push rod the same distance in both directions, and that the travel limits of the servo arm are not exceeded.

There are installations in which the travel of the push-pull tube exceeds the allowable 2 1/2". For such installations, the drive can be applied to a bell crank at a radius point that moves the desired 2 1/2" of maximum allowed travel in the outermost hole of the arm.

When there is no way to have a drive point of less than 2 1/2" or when the primary control is cable-driven it is necessary to use the capstan-cable servo drive. When this is done the servo should be mounted so that the 1/16" diameter cable which wraps around the capstan when extended parallel to the primary cable is approximately 3/16" from the primary cable. If the primary control travel does not exceed 5" the cable-locking pin will be 180° away from the point at which the cable leaves the capstan. When the primary control is at the neutral point this means the total cable wrap around the capstan is 360°. If the primary control travel is greater than 5" the cable wrap is 720° and the pin is adjacent to the output point when the primary control is at the neutral point.

The cable clamps when properly installed will not slip and thus get loose, but it is desirable to nicopress or swedge a fitting on to the cable so as to provide added assurance that the cable will not become slack. If the bridle cable is not sufficiently tight, there will be lost motion in the autopilot drive. This will result in hunting (oscillation).

## Magnetic Considerations

Because the autopilot contains a built-in magnetometer for a **backup source** of heading in the event of GPS loss, it is important to try to locate the programmer away from known sources of magnetic disturbance. The calibration procedure can account for a moderate amount of fixed disturbance (for example, nearby iron objects) but it cannot adjust for changing magnetic fields such as would be generated by aircraft compasses or certain electrical devices. One such source of such problems is the “Flag” mechanism in some older DG or HSI devices. These units use a solenoid to hold the flag out of sight, and the magnetic field will then change when the flags come and go. If at all possible, place the autopilot so as to be as far as possible from such devices. A hand-held compass can be used to assist in finding fixed or variable disturbances prior to installation of the autopilot. Even a few inches can make an appreciable difference in the magnetic disturbance level. It should be noted also that strobe light controls, landing lights, navigation lighting, pitot heat, generate very strong currents in their wiring, thus they will create a periodically pulsating magnetic field disturbance. Shielding has no effect on this problem; the only solution is to keep wiring as far away as possible from any electronics which can be affected by pulsating magnetic fields.

## RFI/EMI considerations

The autopilot programmer is shielded and does not generate any appreciable level of electromagnetic interference. Moreover, the servo lines (except for power and ground) are low-current and cannot contribute to RF interference. The servo power and ground lines do have switching currents through them, but so long as there are no parallel runs of servo power and ground lines with such things as poorly-shielded antenna lines or strobe light power lines, there is no need to shield the servo harnesses.

The autopilot itself has been internally protected from RF interference and has been tested under fairly extreme conditions, such as close proximity to transmitting antennas. However, it is always good practice to insure that such antennas are properly shielded and not routed directly over or under sensitive panel-mounted electronic equipment. Most problems in this area are the result of improper RF shielding on transmitting antennas, microphone cables, and the like. The most sensitive input to the autopilot is the Control Wheel Switch input. This line should not be routed in parallel with transmitting antennas or other sources of known RF interference. If necessary, it can be shielded with the shield connection to pin 8 of the autopilot connector.

## Specific connections for certain commonly-used in-panel GPS units

Note that the information in the tables is based upon the best information available from each manufacturer’s documentation at the time of publication. Please consult the appropriate installation manual for confirmation of wiring information.

# GPS Setup Guide

## Portable GPS’s

Many new handheld GPS’s have adequate output required to fly a TruTrak autopilot. Although most support data output not all handhelds will provide consistent and reliable information required to fly all TruTrak autopilots. Therefore, some handhelds will not fly the airplane well. Performance may decline by putting the processor in high-load situations.

We require a data output rate of once per second for best performance. Some handhelds output data at longer intervals than once per second. These handhelds will cause the autopilot not to perform well in turns and it may cause overshooting and hunting. If the baud rate is selectable the optimum setting is 4800. Most handhelds will require a data cable that plugs into the handheld and provides a medium for data output. This is an accessory and is available from your GPS manufacturer. The setup procedures are in your GPS manual. If your GPS is not listed here consult your GPS manual for NMEA output setup. The autopilot must have a direct connection with the handheld GPS to provide the autopilot with RS-232. To allow the handheld GPS to be removed easily you should add a connector in your panel. We recommend that you use a 9 pin D subminiature connector in your panel that will mate to the harness from the GPS. This will also allow you to wire power and ground and use the aircraft electrical system to power your handheld GPS.

## Magellan GPS 315 A

The Magellan GPS 315 A requires a Power/Data Cable (Magellan Product Number 730276) to provide data output. The Magellan GPS 315 A must be configured to provide the correct output to the autopilot.

Press the **MENU** key then select “Setup. Press **ENTER**. Select “NMEA” and press **ENTER**. Select “V2.1 GSA” then press **ENTER**. Next we must set the baud rate. Press **MENU** then select “SETUP” and press **ENTER**. Next Select “BAUD RATE” and press enter. Select 4800 for the baud rate. Press **ENTER**.

Note that this is the baud rate that will entered into the autopilot in the setup mode.

### Garmin GPS III

The Garmin III requires a Power/data cable (Garmin Part Number 010-10082-00) to provide data output.

The Garmin III must be configured to provide the correct output to the autopilot.

Press the **MENU** key twice. Select 'Setup'. Press **ENTER**. Select the 'Interface' tab. Press **ENTER**. Select the NMEA format.

Note: The default baud rate is 4800. This is the baud rate that will be entered into the autopilot in the setup mode.

### GPS 92

The Garmin 92 requires a Power/data cable (Garmin Part Number 010-10082-00) to provide data output. The Garmin 92 must be configured to provide the correct output to the autopilot.

Press the **PAGE** key until the 'Main Menu' appears. Select 'Setup Menu' and press **ENTER**. Next select 'Interface.' Press **ENTER**. Select NONE/NMEA.

Note: The default baud rate is 4800. This is the baud rate that will be entered into the autopilot in the setup mode.

### Garmin GPS 195

The GPS 195 provides data output every two seconds and may be slow in recognizing turns and will overshoot the desired track. This may cause the autopilot to wander and not perform well in turns.

The Garmin 195 requires a Power/data cable (Garmin Part Number 010-10135-00) to provide data output. The Garmin 195 must be configured to provide the correct output to the autopilot.

Press the **MENU** key twice. Select 'Set-Up Menu'. Press **ENTER**. Select 'Input/Output'. Press **ENTER**. The input/output format is 'No In/NMEA Out.' Note that the baud rate is automatically set at 4800 bps.

Note: This is the baud rate that will need to be entered in the setup mode of the autopilot.

Now the Garmin 195 is correctly set up to provide the RS-232 serial output required by your TruTrak autopilot.

### Garmin GPS 196

The Garmin 196 requires a Power/data cable (Garmin Part Number 010-10082-00) to provide data output.

The Garmin 196 must be configured to provide the correct output to the autopilot.

Press the **MENU** key twice. Use the arrow keypad to select the 'SETUP' tab.

Within the Setup Menu select the 'INTERFACE' tab. Using the arrow keypad highlight the 'Serial Data Format' field. Use the arrow keypad to select 'NMEA In/NMEA Out' and press **ENTER**.

Set the baud rate to 4800.

Note: This is the baud rate that will need to be entered in the setup mode of the autopilot.

Press **MENU** to enter the Advanced NMEA page. Select 'Advanced NMEA Setup' and press **ENTER**.

Using the arrow keypad and the **ENTER** key to turn OFF 'GPS Status (GSA, GSV)', 'Waypoint/Route (WPL, RTE)', and 'GARMIN Proprietary'.

Now the Garmin 196 is correctly set up to provide the RS-232 serial output required by your TruTrak autopilot.

### Garmin 295

The Garmin 295 requires a power/data cable (Garmin Part Number 010-10082-00) to provide data output. The Garmin 295 must be configured to provide the correct output to the autopilot.

Press the **MENU** key twice. Use the rocker keypad to select the 'INTERFACE' tab.

Press the down portion of the rocker keypad to select the 'FORMAT' field.

Press **ENTER** and a popup window will show the available settings.

Use the rocker keypad to select 'NMEA OUT' then press **ENTER**. Select 4800 for the baud rate.

Note: This is the baud rate that will need to be entered in the setup mode of the autopilot.

Now the Garmin 295 is correctly set up to provide the RS-232 serial output required by your TruTrak autopilot.

## Garmin 296

The Garmin 296 must be configured to provide the correct output to the autopilot.

Press the **MENU** key twice. Use the rocker keypad to select the SETUP in the vertical tabs. Use the rocker keypad to select the 'COM 1' tab.

Press the down portion of the rocker keypad to select the 'FORMAT' field.

Press **ENTER** and a popup window will show the available settings.

Use the rocker keypad to select 'NMEA IN / NMEA OUT' then press **ENTER**. Select 4800 for the baud rate. Note: This is the baud rate that will need to be entered in the setup mode of the autopilot.

Press **MENU** to enter the Advanced NMEA page. Select 'Advanced NMEA Setup' and press **ENTER**.

Using the arrow keypad and the **ENTER** key to select "FAST OUTPUT" or turn OFF 'GPS Status (GSA, GSV)', 'Waypoint/Route (WPL, RTE)', and 'GARMIN Proprietary'.

Now the Garmin 296 is correctly set up to provide the RS-232 serial output required by your TruTrak autopilot.

## Garmin 396

The Garmin 396 must be configured to provide the correct output to the autopilot.

Press the **MENU** key twice. Use the rocker keypad to select the SETUP in the vertical tabs. Use the rocker keypad to select the 'Interface' tab.

Press the down portion of the rocker keypad to select the 'Serial Data Format' field.

Press **ENTER** and a popup window will show the available settings.

Use the rocker keypad to select 'NMEA IN / NMEA OUT' then press **ENTER**. Select 4800 for the baud rate. Note: This is the baud rate that will need to be entered in the setup mode of the autopilot.

Press **MENU** to enter the Advanced NMEA page. Select 'Advanced NMEA Setup' and press **ENTER**.

Using the arrow keypad and the **ENTER** key to select "FAST OUTPUT" or turn OFF 'GPS Status (GSA, GSV)', 'Waypoint/Route (WPL, RTE)', and 'GARMIN Proprietary'.

Now the Garmin 396 is correctly set up to provide the RS-232 serial output required by your TruTrak autopilot.

## Garmin 496

The Garmin 496 must be configured to provide the correct output to the autopilot.

Press the **MENU** key twice. Use the rocker keypad to select the SETUP in the vertical tabs. Use the rocker keypad to select the 'Interface' tab.

Press the down portion of the rocker keypad to select the 'Serial Data Format' field.

Press **ENTER** and a popup window will show the available settings.

Use the rocker keypad to select 'NMEA IN / NMEA OUT' then press **ENTER**. Select 4800 for the baud rate. Note: This is the baud rate that will need to be entered in the setup mode of the autopilot.

Press **MENU** to enter the Advanced NMEA page. Select 'Advanced NMEA Setup' and press **ENTER**.

Using the arrow keypad and the **ENTER** key to select "FAST OUTPUT" or turn OFF 'GPS Status (GSA, GSV)', 'Waypoint/Route (WPL, RTE)', and 'GARMIN Proprietary'.

Now the Garmin 496 is correctly set up to provide the RS-232 serial output required by your TruTrak autopilot.

## Lowrance Airmap 100

The Lowrance Airmap 100 requires a NMEA/DGPS adapter cable to provide data output. The Lowrance Airmap 100 must be configured to provide the correct output to the autopilot.

Press the **MENU** key then select "NMEA/DGPS CONFIG" from the "System Setup" menu. Highlight the "NMEA OUT" menu then press the right arrow key.

Note: The default baud rate is 4800. This is the baud rate that will be entered into the autopilot in the setup mode.

Now the Lowrance Airmap 100 is correctly set up to provide the RS-232 serial output required by your TruTrak autopilot.

## Lowrance Airmap 1000/2000

The Lowrance Airmap 1000/2000 requires a NMEA/DGPS adapter cable to provide data output. The Lowrance Airmap 1000/2000 must be configured to provide the correct output to the autopilot. AirMap has one NMEA 0183 version 2.0 compatible communication port,

Press **MENU|MENU|↓** to **SYSTEM SETUP|ENT**. Press **↓** to **COMMUNICATIONS PORT|ENT**. Select 9600 Baud. This is the baud rate that will entered into the autopilot in the setup mode. Select “NMEA OUT”

Now the Lowrance Airmap 1000/2000 is correctly set up to provide the RS-232 serial output required by your TruTrak autopilot.

## AvMap EKP IV

The AvMap EKP IV requires a NMEA/DGPS adapter cable to provide data output. The AvMap EKP IV must be configured to provide the correct output to the autopilot.

MENU’ 1 sec. + “COMMUNICATIONS” + ‘ENTER’ + “NMEA OUTPUT” + ‘ENTER’.

The Output NMEA0183 messages are RMC, RMB that need to be selected.

Note: The default baud rate is 4800. This is the baud rate that will entered into the autopilot in the setup mode. The yellow wire is the Data out TX wire.

Now the AvMap EKP IV is correctly set up to provide the RS-232 serial output required by your TruTrak autopilot.

## Garmin 35-HVS

Connect Red to Power and Black to Ground then Blue to Serial input.

The default baud rate is 4800. This is the baud rate that will entered into the autopilot in the setup mode.

There is no necessary setup procedure for the Garmin-35 unit. It may require up to 45 minutes to achieve a position fix the first time it is powered on; afterwards it will take less time to obtain a position fix as it contains its own battery and position memory. To use this unit, configure the DigiFlight II’s baud rate to 4800 baud in the setup screen. **This unit does not provide GPS-NAV information, course guidance, or flight planning.** Its sole function is to provide the autopilot with a source of ground track and ground speed information to slave the autopilot’s internal DG function.

## Panel mount GPS’s

### Garmin 155XL/250XL/300XL

Garmin 155XL/250XL/300XL connections to TruTrak autopilot			
J1 on Garmin unit	Signal Name (Garmin)	Signal Name (TruTrak)	P101 on TruTrak Sorcerer
24	GPS RS 232 OUT 1	Primary Serial Input	17
16	GPS ARINC 429 OUT A	ARINC-A	14
15	GPS ARINC 429 OUT B	ARINC-B	15

Remove the data cards turn the unit on. Press “enter” in response to “Select operating mode Normal?” Press “enter” in response to “No Jeppesen database rte / prx limited to user wpts ok?” After the satellite status page is displayed for 5 seconds the unit may be turned off.

With power OFF press and hold the ENT key and turn the power on (release the ENT key when the display activates). You should be in the TEST MODE. Rotate the outer knob to advance to I/O Channel 1. Press the CRSR key then rotate the outer knob to Select Output rotate inner knob to select “Aviation”. Press the CRSR key then rotate the outer knob to Select ARINC 429 CHANNEL. Press the CRSR key then rotate the inner knob to advance to OUTPUT and select “w/o GAMA labels”

Note that for the Garmin units, the autopilot will need to be set for 9600 baud.

## Garmin 430 and 530

Garmin 430 and 530 connections to TruTrak autopilot			
P4001 [P5001] on Garmin 430 [530]	Signal Name (Garmin)	Signal Name (TruTrak)	P101 on TruTrak Sorcerer
56	GPS RS 232 OUT 1	Primary Serial Input	17
46	GPS ARINC 429 OUT A	ARINC-A	14
47	GPS ARINC 429 OUT B	ARINC-B	15

Power 430/530 up and turn it on while holding down the ENT key. Release the ENT key when the display activates. After the data base pages, the first page displayed is the MAIN ARINC 429 CONFIG page. While in Configuration mode, pages can be selected by ensuring the cursor is off and rotating the small right knob. To change data on the displayed Configuration Page, press the small right knob (CRSR) to turn on the cursor. Turn the large right knob to change between data fields. Turn the large or small right knob to change a field that the cursor is on. Once you have made the desired selection, press the ENT key to accept the entry.

With the MAIN ARINC 429 CONFIG page displayed, on the row labeled OUT, select SPEED → Low and DATA → ARINC 429.

Advance to the MAIN RS232 CONFIG page.

On the row labeled CHNL1, select OUTPUT → Aviation.

Note that for the Garmin units, the autopilot will need to be set for 9600 baud.

## UPSAT GX-50/60/65

UPSAT GX-50/60/65 connections to TruTrak autopilot			
37-Pin Connector on UPSAT GX-50/60/65	Signal Name (UPSAT)	Signal Name (TruTrak)	P101 on TruTrak Sorcerer
5 or 22	Use pin 5 – TxD1 – if GX has no GPSS	Primary Serial Input	17
	Use pin 22 – TxD2 – if GX has GPSS		

Power the GX-50/60/65 up and turn it on while holding down the leftmost and rightmost “smart keys.” Rotate the LARGE knob to the Serial Interface Configuration “CH RX TX” page. Press SEL (the selection fields will start flashing), rotate the LARGE knob to select the port, rotate the SMALL knob to select the desired configurations, and then press ENT when complete.

If both the GX unit AND the DigiFlight unit have GPSS capability,  
select “GPSS” for CH 2, TX column, and wire pin 17 on the DigiFlight IIVSG to pin 22 of the GX unit

Otherwise

select “MOVING MAP” For CH 1, TX column and wire pin 17 on the DigiFlight II / IIVS to pin 5 of the GX unit

To restore the GX-50/60/65 to normal operation, switch its power off, and then back on.

Note that for the GX-50/60/65 units, the autopilot will need to be set for 9600 baud.

## Garmin AT GNS480

Garmin AT GNS480 connections to TruTrak autopilot			
P1 on GNS480	Signal Name (Garmin AT)	Signal Name (TruTrak)	P101 on TruTrak Sorcerer
22	RS232 TxD2	Primary Serial Input	17
P5 on GNS480	Signal Name (Garmin AT)	Signal Name (TruTrak)	P101 on TruTrak Sorcerer
4	429 OUT 1A	ARINC-A	14
24	429 OUT 1B	ARINC-B	15

Power 480 up and select the **1, 4, MENU/ ENTER** keys immediately after the GNS 480 initialization is complete. After restart, the first page displayed is the SETUP page. Select the SERIAL PORTS with the button next to it. Press the small knob to enter the edit mode and move to the TX column for the channel that you have connected the serial wire to (channel 2). Select MAPCOM and 9600. Press the small inner knob again to save. Then press the BACK to go back to the Setup page.

Select the ARINC PORTS SETUP. With the MAIN ARINC 429 CONFIG page displayed, on the row labeled Channel 1 OUT, select and DATA → ARINC 429, SPEED → Low.

Serial output baud rate should be set to 9600 on the GNS480. Set the TruTrak baud rate to 9600.



## DigiTrak Ground Checkout



### Must be performed before first flight



Once wiring is completed the autopilot should be tested in the aircraft while on the ground. The first step is to enter the setup mode on the autopilot and set all parameters to their correct values. Apply power to the autopilot programmer.

When power is first applied to the unit, the display will show three flashing dash (“-”) characters. After approximately ten seconds, the autopilot is ready to be set up for operation, indicating three non-flashing dashes on the display. (If a GPS unit happens to be connected to the autopilot, has a valid position fix, and is running at the correct baud rate, the autopilot will indicate the word “OFF” instead of the three dashes.)

Engage the autopilot by pressing **ON/OFF**. Then press and hold  and  at the same time, until the first setup screen is displayed.

This display will show a flashing “1” and a two-digit number from 0 to 24, representing the autopilot activity level (default 6). With the activity setup screen on the display, use  or  as necessary to adjust the lateral activity value to a value of 1 or 2. Press **ON/OFF** to enter the activity value and advance to the next screen.

The second setup screen, with a flashing “2” is used to set the torque of the autopilot servo (default 12). Use  or  to adjust the torque value close to the maximum value of 12. Once that is done, press **ON/OFF** to enter that value and advance to the next screen.



The third setup screen, with a flashing “3” is used to set the baud rate (speed) of the serial interface to the GPS receiver (default 96). Use  or  to select the Baud rate that matches your GPS unit. Only the first two digits are shown.

Having chosen the desired baud rate, press **ON/OFF** to enter that value and advance to the next screen.



The fifth setup screen, with a flashing “4” provides the option for calibrating the internal backup magnetometer. To this question, leave the answer set to 0 (which means “no”) at this time. This operation will be done at a later time during flight testing.

Press **ON/OFF** to leave the setup mode. The DigiTrak display will now show “-|-” indicating the magnetic “heading-hold” mode. (If GPS were indicating sufficient ground-speed for flight, the display would be showing a 3-digit selected ground track instead.)

Press **ON/OFF**. The DigiTrak display will now return to its disengaged (off) state, which is three “-” characters if no GPS fix has been obtained, or “OFF” if a GPS position fix has been obtained.

While the autopilot is in its disengaged (off) mode, press and hold  and  simultaneously. The display will now show “-|-|-” with the center dash character blinking, indicating the Manual Gyro Set operation. Continue to hold both buttons in for a 5 -10 seconds while the autopilot is not being moved about, to re-center the gyro manually

The next step in the check-out procedure is to verify that the servo runs, and in the correct direction. Press **ON/OFF** to again engage the autopilot. The servo should be responding at this time, moving the controls only very slowly in attempt to hold magnetic heading constant. Press and hold  for about 1-1/2 seconds. The autopilot will now move the controls in an attempt to cause a constant-rate turn towards the right. If servo direction is not correct, the wires going to pins 4 and 5 of the roll servo (pins 11 and 12 on the main connector) must be reversed to achieve the correct response. If the servo does not move at all, double-check the torque setting (setup screen 2) to make sure it is at least 10. If a servo jitters but does not actually rotate, check the wiring on the four servo drive lines to that servo for continuity and correctness. If the servo does not seem to have any torque, check the roll torque control line for continuity and correctness. With a torque setting of 12, and the autopilot engaged, the torque control line should measure approximately 4.9 volts DC.

Press and release  to stop the continuous turn. Then press and hold  for about 1-1/2 seconds. The autopilot will now move the controls in attempt to cause a constant-rate turn to the left. Notice the stroboscopically-moving display indicating the autopilot is in its constant-turn mode.

Press and release  to stop the continuous turn.

While the servo is running, check that the servo arm or capstan is properly operating the controls. For servo installations using an arm, check that as the controls go from limit to limit the arm of the servo remains in the operating range of the servo (a maximum of 100 degrees total rotation) and that when the controls are centered, the connecting push rod is approximately perpendicular to the arm of the servo. For capstan systems, insure that the cabling remains at proper tension and is properly secured as the servo moves the controls from stop to stop. Insure that the servo remains secure in its mounting and does not flex its mounting bracket as it drives the control to its stops. For installations using an arm, insure that as the servo moves the control towards the end of control travel it does not cause the main control’s torque tube to flex in any way that could cause control system lockup at the extremes of servo travel. Insure that any “lost motion” in the linkages is eliminated or minimized, in order to maximize the performance of the autopilot. Lost motion (dead zone) will result in wandering or slow “hunting” behavior in flight. Lost motion in the linkage can best be observed by temporarily clamping the servo arm and gently moving an aileron back and forth, while observing how much aileron movement takes place against the clamped servo.

The next step in the check-out procedure is to verify that the serial input from the GPS receiver is being properly received and interpreted. With the aircraft outside of any building, power up the GPS receiver and the autopilot. After the GPS receiver acquires its position, the autopilot display will change from “---” to “OFF” indicating that valid position data is available.

If the word “OFF” is not displayed, even after it is known that the GPS unit has a position fix, the problem must be diagnosed. Possible reasons for such a problem are,

- Pin 3 on the connector is not wired to a source of RS-232 serial data. Check wiring.
- The GPS receiver’s baud rate disagrees with that selected within the autopilot. Match up Baud rates.
- The GPS receiver’s serial output port has not been properly configured to provide RS 232 output. See GPS documents for proper configuration.

## Summary:

**ENGAGE AUTOPILOT WITH FLIGHT CONTROL CENTERED, TAP RIGHT BUTTON SEVERAL TIMES. FLIGHT CONTROL MUST MOVE TOWARD RIGHT. TAP LEFT BUTTON SEVERAL TIMES, FLIGHT CONTROL MUST MOVE BACK TOWARD LEFT.**

## DigiTrak First Flight

### **THE FIRST FLIGHT SHOULD BE DONE AFTER HAVING COMPLETED ALL THE SETUP AND TESTING ON THE GROUND.**

For the first flight, it is important that the GPS unit is properly functioning with the autopilot, so that the dynamics of flight can be set without consideration of the calibration of the magnetic backup system. As discussed earlier, when there is proper connection to the serial input of the autopilot, the display will show "OFF" when it is disengaged and valid GPS data is present. If this does not occur, it is best to diagnose and fix the problem prior to first flight of the autopilot.

The activity adjustment (setup screen 1) determines how briskly the autopilot responds to roll disturbances. The setting can be adjusted, in flight, over a wide range; thus the autopilot can be tailored to adapt to any aircraft installation.

The activity adjustment covers a numeric range of 0 to 24. Unless the value for a particular aircraft is provided by TruTrak, it is advisable to start with a setting of zero (0) and work up from there. Most installations would ultimately require somewhat higher settings.

On the first flight, manually fly the aircraft to a suitable area for testing. Engage the autopilot by pressing **ON/OFF**. Observe that the display now shows the captured GPS ground track as the selected direction of flight.

Press and hold the **←** and **→** buttons simultaneously until the first setup screen is shown on the display. The digit "1" will be flashing, followed by the activity value that was set earlier during pre-flight setup. Use **←** to select the value zero (0), and observe the resulting control movement. Using **→**, increase the value one setting at a time, taking time to observe an increasing level of control response. At some point, if too high a setting is chosen, the autopilot will be jittery (rapidly move the stick back and forth) and over-active. Back the setting down using **←** until the autopilot is responsive but not over-active. It is best if these adjustments are made in conditions of light to moderate turbulence (the TruTrak loves turbulence) so as to make it easy to observe the response of the autopilot to disturbances. It will be noted that a fairly limited range of activity setting will be acceptable; too low a value will result in sluggish response, while too high a value will result in nervous, inappropriate response. Within this acceptable range there is room for individual preference; some people prefer a more aggressive autopilot than others. It should be noted that any builder can accomplish this adjustment procedure and no professional is required.

Once the desired activity level is established, press **ON/OFF** to store the value and move to the second setup screen.

In the second setup screen, the digit "2" will be flashing, followed by the torque value that was set earlier during pre-flight setup. Again, it is best that this be done in light to moderate turbulence. The reason is that more torque is required of the autopilot in turbulence than is the case in still air, because the velocity of the servo is greater as turbulence requires more rapid servo movement. This means that the higher the activity setting, the higher the required torque setting.

The reason for setting the torque to a setting less than its maximum (12) is to reduce the current draw of the servo and to make it easier to override the autopilot should the need arise, (normally not less than 10). Manual override is not normally required, as using the control-wheel switch or **ON/OFF** will disengage the autopilot, but it is best to have a setting of torque which can be comfortably overridden if necessary. Starting with the maximum torque setting (12), gradually decrease the value using **←**, until it is observed that the autopilot no longer has the necessary torque to respond to disturbances; then increase the setting somewhat from that level using **→** until no more slippage of the servo is observed. The clearest evidence of servo slippage is that the autopilot is no longer able to roll the aircraft back to a level attitude after a roll disturbance occurs.



Once the desired torque level is established, press **ON/OFF** to store the value. Press **ON/OFF** two more times to skip over setup screens 3, and 4 and return to the primary flight display in which the selected GPS ground track appears on the display.

**The setup procedure can be repeated whenever it is desired to modify the dynamic flight characteristics of the autopilot.**

## Magnetic Calibration

The DigiTrak autopilot contains a built-in magnetometer which is used to maintain gyro centering and slaving for the built-in Electronic DG of the autopilot **in case of GPS loss**. This magnetometer is calibrated at the factory in a disturbance-free environment, but once installed in the aircraft it may be necessary to account for any fixed magnetic disturbances in the aircraft itself.

For best results, this operation should be done on a day when the winds are relatively calm, so that air is still and heading and ground track are approximately the same in all directions. The operation should be deferred until such flight conditions exist. For this operation the autopilot will fly four legs of approximately half a minute each, first north, then east, then south, then west. Prior to the calibration sequence, fly the aircraft to an area where this can suitably be done. **Verify that the autopilot is receiving GPS properly** (note that “OFF” appears in the display when the autopilot is off, and the selected ground track appears when the autopilot is on). The calibration will not function without GPS. Choose and hold an appropriate altitude and engage the autopilot using **ON/OFF** or the control stick switch. During the calibration sequence, it is important that aircraft pitch attitude remain as constant as possible.

Once the autopilot is engaged, press  and  simultaneously until the first setup screen appears. Press **ON/OFF** four times, to cycle through the activity, torque and baud rate setup screens until the fourth setup screen shows on the display. This will be a flashing digit “4” followed by the digit “0”. Press  to select 1 (for “yes”) and then press **ON/OFF**. The autopilot screen will announce the beginning of the calibration sequence with the digits “000” flashing as it turns the aircraft towards North. It will fly the aircraft to a ground track of 000 degrees, and once established on course the digits will cease flashing as the autopilot gathers and averages magnetometer readings for this direction. This process requires approximately ten to twenty seconds of steady flight on a ground track of 000 degrees. Having gathered the required data, the autopilot will announce its turn towards East with a flashing “090” display. Again, the autopilot rolls out and gathers data. This process is continued through South and finally West. Having completed this operation, the display will change to “- C -” indicating that calibration has been successful. (A display of “- F -” at any time during the magnetic calibration sequence means that the GPS signal has been lost and the calibration cannot be completed. Repeat the calibration once reliable GPS reception is again present.) Confirm the calibration sequence by pressing **ON/OFF**. At this point, the autopilot will revert back to its normal flight mode with a direction selector, but it now has a magnetic backup mode sufficient to fly the aircraft drift-free in the event of GPS loss.

This concludes the in-flight setup of the DigiTrak autopilot

## Definitions

ACTIVITY	(Setting range 0 – 24) The velocity at which the servo moves the control surface. The higher the number the more movement you will see in the control surface. With a standard servo (DSB-X, DSP-X) you should start at 0 then work your way up in flight to set the level for your aircraft. The High Torque Servo (DSB-HB, DSB-HC) has a different gear ratio, so an Activity setting of 12 will be equal to about 0. With too low a setting the aircraft will hunt slowly and appear to be lazy. With too high a setting the aircraft will hunt rapidly, and appear nervous and jittery.
TORQUE	(Setting range 0-12) The holding force that the servo has on the control surface. This setting should not be too low; the reason is that the servo will not be able to fly the aircraft in turbulence. The lower the setting the easier it is to override the servo if you need to. It is recommended that the torque be set in moderate turbulence, so that one can be certain that the level is not set too low.
BAUD RATE	(Setting Range 600-9600) This is the communication speed that must match your GPS serial output setting. Most handhelds are 4800 and most panel mounts are 9600.

## DigiTrak Settings

Engage the autopilot by pressing and releasing the ON OFF button. Then press and hold both arrow buttons for approximately 5 seconds, until the first setup screen is displayed.

### “1” LATERAL ACTIVITY

Tap the correct arrow button as necessary to adjust the lateral activity value to a value of 1 or 2. Press and release the ON OFF button to advance to next setup screen.

### “2” LATERAL TORQUE

Tap the correct arrow button as necessary to adjust the torque value close to the maximum value of 12. Press and release the ON OFF button to advance to next setup screen.

### “3” BAUD RATE

Select either 48 or 96. Where 48 is a baud rate of 4800 and 96 is a baud rate of 9600. Press and release the ON OFF button to advance to next setup screen.

### “4” MAGNETIC CALIBRATION

This is the option for calibrating the internal backup magnetometer. To this question, leave the answer set to 0 (which means “no”) at this time. This operation will be done at a later time during flight testing. Press and release the ON OFF button to leave the setup

## Electrical Pin-out

The table below provides a brief explanation of each pin function on the main 15-pin connector P101.

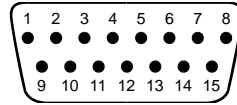

Rear 15-Pin Connector P101  
Viewed looking at wire side of connector

P101 Pin	Function	Notes																										
1	<b>Autopilot Master</b> (+12 to +14 V DC). The autopilot itself draws less than 0.3 ampere. Most of the current required by the system is used by the servo (up to 1Amp depending on torque setting) and a smaller amount (up to 180 mA) for the illuminated pushbuttons.																											
2	<b>Control Wheel Switch</b> . Connect as shown in wiring diagram to a SPST momentary switch located remotely to the autopilot for convenient engage/disengage function.																											
3	<b>Primary Serial Input</b> . Baud rate selectable, normally 4800 or 9600 baud. Automatically decodes NMEA-0183, Garmin Aviation Format, or Apollo/UPSAT Moving-Map format. Provides directional reference to the autopilot.																											
4,5,6	Reserved. Do not connect to these pins.																											
7	<b>Roll Servo Torque Control</b> . A signal from the autopilot to the roll (aileron) servo which sets the amount of torque to be delivered by the servo.																											
8	<b>Ground Connection</b> . Provide #20 AWG to common grounding point.																											
9	<b>Power Connection to Servo</b> . Provide #20 AWG to Servo Pin 1.																											
10	<b>Instrument Lamp Dimmer</b> . A source of variable DC from external dimming control module. Drives the LED brightness control and three 60 mA lamps. If left disconnected, LED will be full-on but buttons will be unilluminated.																											
11 12 13 14	<table border="1"> <tr> <td colspan="3"><b>Roll (aileron) Servo control lines</b>. These lines cause the stepping motor in the roll servo to run in the appropriate direction at the desired velocity. They are small-signal lines and do not have any substantial current-carrying capability or require any special shielding. Connect to roll servo as shown on wiring diagram.</td> <td rowspan="5">Reverse servo direction if necessary by swapping wires on pin 11 and 12.  See note 3 on wiring diagram also.</td> </tr> <tr> <td colspan="3">Wiring to roll servo J201</td> </tr> <tr> <td></td> <td>Direction of servo arm / capstan rotation (as viewed from face of the servo body) for <b>RIGHT</b> aileron</td> <td></td> </tr> <tr> <td>J101</td> <td>Pin 11</td> <td>Pin 12</td> </tr> <tr> <td>Standard</td> <td>J201-4</td> <td>J201-5</td> </tr> <tr> <td>Reversed</td> <td>J201-5</td> <td>J201-4</td> </tr> <tr> <td></td> <td></td> <td></td> <td>Servo CCW (counter-clockwise) → RIGHT</td> </tr> <tr> <td></td> <td></td> <td></td> <td>Servo CW (clockwise) → RIGHT</td> </tr> </table>	<b>Roll (aileron) Servo control lines</b> . These lines cause the stepping motor in the roll servo to run in the appropriate direction at the desired velocity. They are small-signal lines and do not have any substantial current-carrying capability or require any special shielding. Connect to roll servo as shown on wiring diagram.			Reverse servo direction if necessary by swapping wires on pin 11 and 12.  See note 3 on wiring diagram also.	Wiring to roll servo J201				Direction of servo arm / capstan rotation (as viewed from face of the servo body) for <b>RIGHT</b> aileron		J101	Pin 11	Pin 12	Standard	J201-4	J201-5	Reversed	J201-5	J201-4				Servo CCW (counter-clockwise) → RIGHT				Servo CW (clockwise) → RIGHT
<b>Roll (aileron) Servo control lines</b> . These lines cause the stepping motor in the roll servo to run in the appropriate direction at the desired velocity. They are small-signal lines and do not have any substantial current-carrying capability or require any special shielding. Connect to roll servo as shown on wiring diagram.			Reverse servo direction if necessary by swapping wires on pin 11 and 12.  See note 3 on wiring diagram also.																									
Wiring to roll servo J201																												
	Direction of servo arm / capstan rotation (as viewed from face of the servo body) for <b>RIGHT</b> aileron																											
J101	Pin 11	Pin 12																										
Standard	J201-4	J201-5																										
Reversed	J201-5	J201-4																										
			Servo CCW (counter-clockwise) → RIGHT																									
			Servo CW (clockwise) → RIGHT																									
15	<b>Ground Connection to Servo</b> . Provide #20 AWG to Servo Pin 9.																											

## Trouble Shooting

Problem	Cause	Corrective Action
No display	No aircraft voltage	Correct power, ground,
DT controller function but no servo movement	No aircraft voltage and /or torque signal to servo	Correct power & ground at servo. Check @5 voltage at pin 6 at servo, AP engaged
DT controller function but servo just clicks	Control wires (pin 2-5 at servo) open or shorted to each other	Correct wire short or servo wires continuity
Commanded right turn causes left turn	Servo wire not installed correctly	Swap wire at servo pins 4 and 5 check wires at 2 & 3 to controller
No GPS communication	GPS not setup correctly or Baud rate not set	Setup GPS communication correctly and match Bauds in both units.

**INSTALLATION NOTES:**

1. USE #20 AWG FOR POWER AND GROUND WIRES AS SHOWN BELOW IN HEAVY LINES (PINS 1,9, 8 AND 15 ON CONTROL UNIT J101, AND PINS 1 AND 9 ON 9-PIN CONNECTOR J201).  
  
ALL OTHER WIRING #20 TO #24 AWG.
2. INSTRUMENT LAMP DIMMER CONTROL IS OPTIONAL.  
CONNECT J101 PIN 10 TO DIMMER CONTROL OR LEAVE UNCONNECTED.
3. REVERSAL OF SERVO DIRECTION CAN BE ACCOMPLISHED IF NECESSARY BY SWAPPING WIRES AT PINS 4 AND 5 OF THE SERVO CONNECTOR (J201).

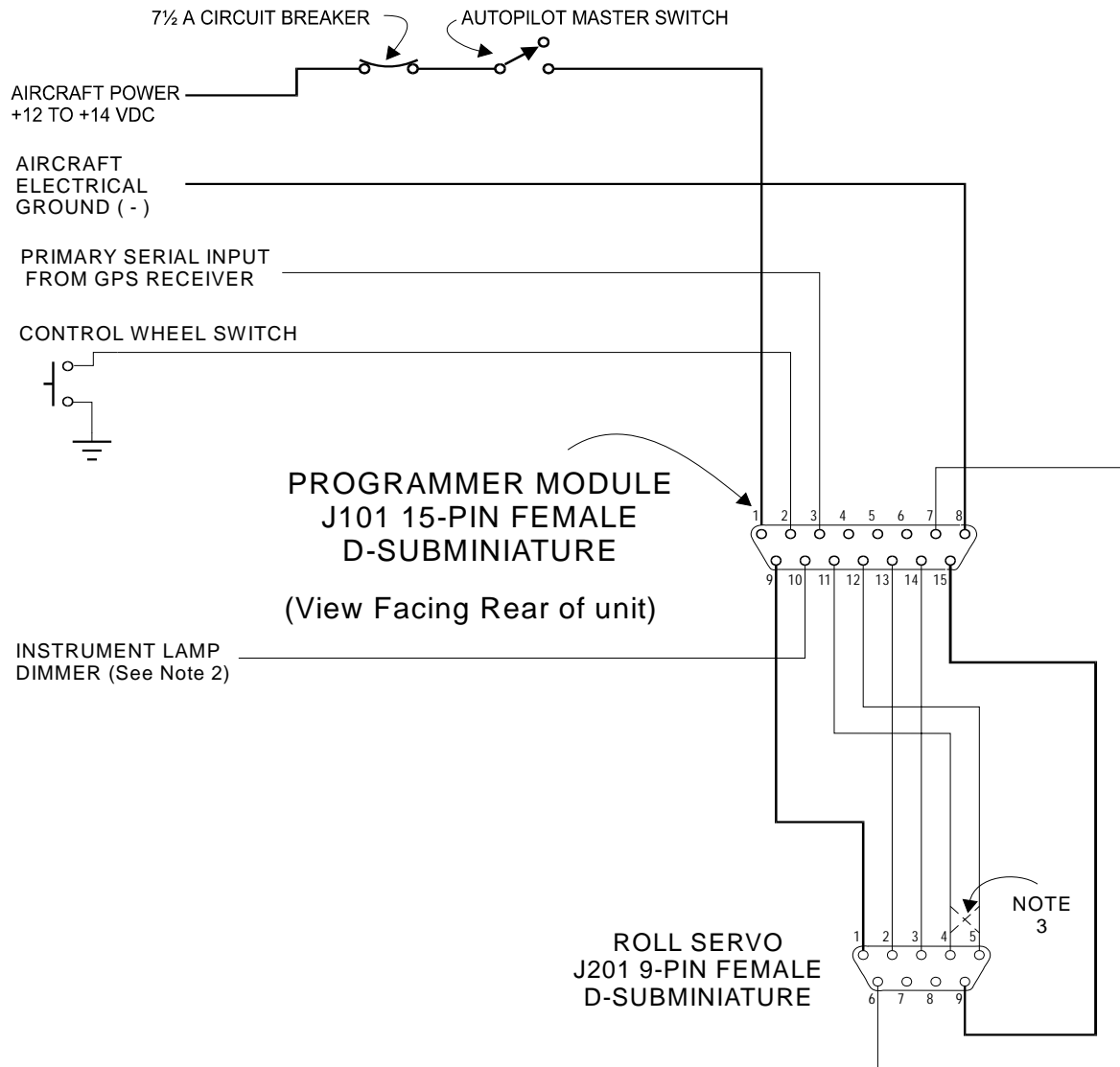

**DIGITRAK EXTERNAL WIRING DIAGRAM**



# DIGITRAK EXTERNAL BLOCK DIAGRAM

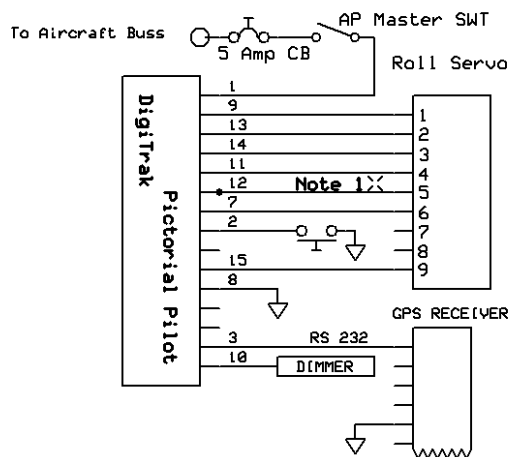

**Note 1:** Reversal of Roll servo rotation is accomplished by swapping wires at pin 4 & 5 at the servo

**Note 2:** Hand held GPS must have a return signal ground

## NOTES



**RETURN MERCHANDISE POLICY AND PROCEDURE**

- Under no circumstances should products be returned to TruTrak without first obtaining a Return of Merchandise Authorization number (RMA #) from TruTrak. An RMA # may be obtained by contacting us at 866-878-8725.
- Products that do not have an RMA # will not be processed.
- Please include some form of documentation stating the reason for the return and describing any symptoms, failure modes, suspected causes of damage, diagnostics performed, data collected, etc.
- Product(s) should be packaged in their original shipping containers. In lieu of this, they should be very carefully packaged in containers suitable to protect them during transit. Note that damage caused during shipping will not be repaired under warranty.
- The outside of the box must be clearly marked with the RMA # issued by TruTrak and the RMA # must also be noted on the return documents.
- Products will be returned to the customer at no charge via FedEx Ground or UPS Ground. If customer requests expedited shipping (2<sup>nd</sup> Day or Overnight) they will be charged the shipping cost and must supply a credit card number.
- Send ALL return shipments to:

Trutrak Flight Systems, Inc.  
1500 South Old Missouri Road  
Springdale, AR 72764  
USA  
Attention: Returns Dept.  
RMA# \_\_\_\_\_

<b>TruTrak Warranties</b>		
<b><u>Product Description</u></b>	<b><u>Warranty Begins</u></b>	<b><u>Length Of Warranty</u></b>
Autopilot Programmer	Date Of Purchase	Limited Lifetime
Autopilot Servo	Date Of Purchase	Limited Lifetime
ADI	Date Of Purchase	Limited Lifetime
Pictorial Turn & Bank	Date Of Purchase	1 Year

**TRUTRAK FLIGHT SYSTEMS**

**1500 S. Old Missouri Road**

**Springdale, AR 72764**

**Ph: 479-751-0250 Fax: 479-751-3397**

[www.trutrakflightsystems.com](http://www.trutrakflightsystems.com)

[info@trutrakflightsystems.com](mailto:info@trutrakflightsystems.com)